

# imou

## Quick Start Guide

Version 1.0.1

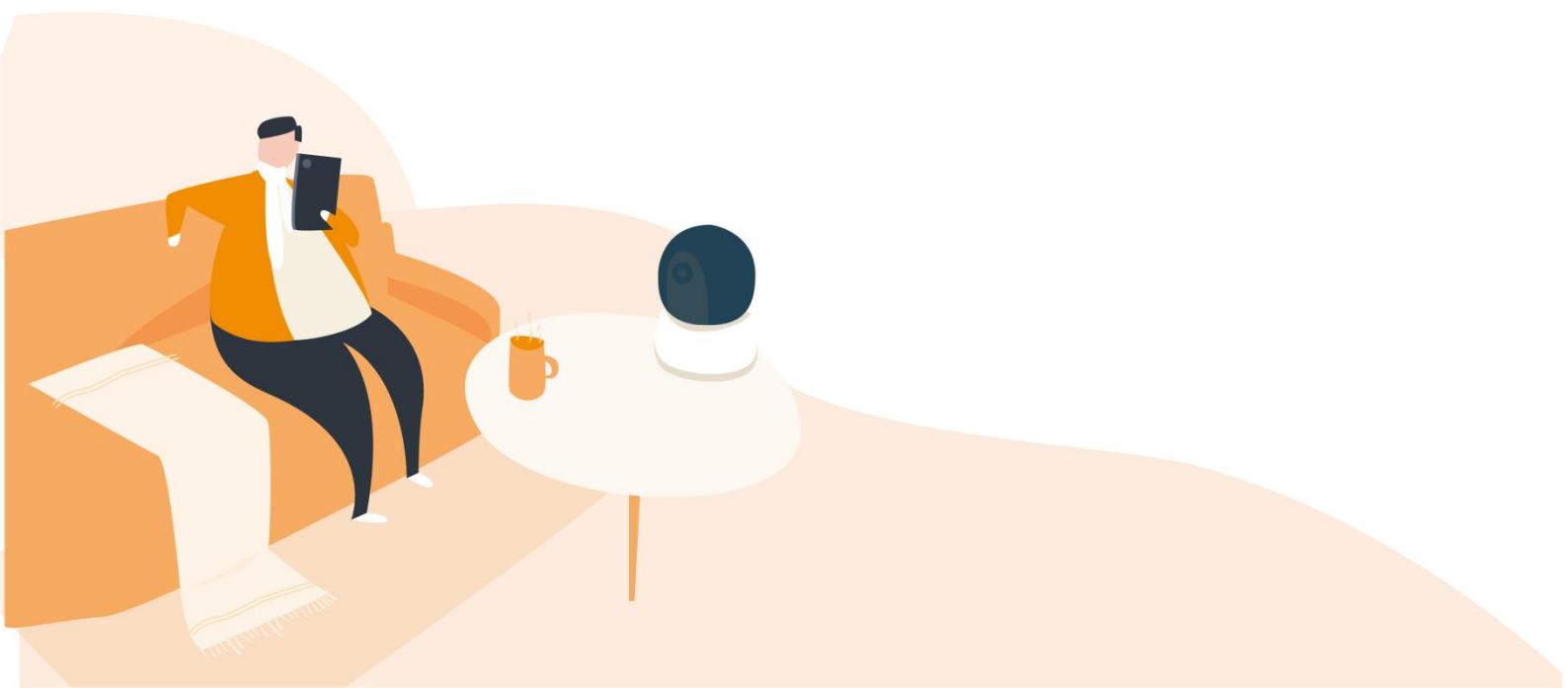



## Contents

<i>Quick Start Guide</i>	1
1 Packing List	1
2 Product Appearance	1
3 Operation by Imou App	2
4 Device Installation	3
<i>Kurzanleitung</i>	5
1 Lieferumfang	5
2 Überblick	5
3 Bedienung über Imou-App	6
4 Installation des Geräts	7
<i>Guía de inicio rápido</i>	9
1 Contenido	9
2 Apariencia del producto	9
3 Funcionamiento usando la aplicación Imou	10
4 Instalación del dispositivo	11
<i>Guide de démarrage rapide</i>	13
1 Contenu de l'emballage	13
2 Différentes faces du produit	13



3	Fonctionnement avec l'application Imou	14
4	Installation de l'appareil	15
	<i>Snelstartgids</i>	17
1	Paklijst	17
2	Kenmerken van het product	17
3	Bediening via de Imou App	18
4	Installatie van het apparaat	19
	<i>Guida introduttiva</i>	21
1	Contenuto della confezione	21
2	Come si presenta il prodotto	21
3	Funzionamento tramite app Imou	22
4	Installazione dispositivo	23
	<i>Guia de Início Rápido</i>	25
1	Lista da embalagem	25
2	Aspetto do produto	25
3	Operação pela Aplicação Imou	26
4	Instalação do dispositivo	27



## Quick Start Guide

### 1 Packing List



Device \*1



QSG \*1

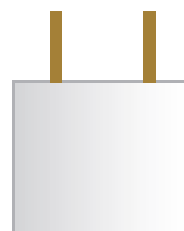

Power Adapter \*1



Screw Package \*1



Quick Installation Board \*1



Installation Position Map \*1

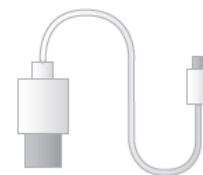

USB \*1

### 2 Product Appearance

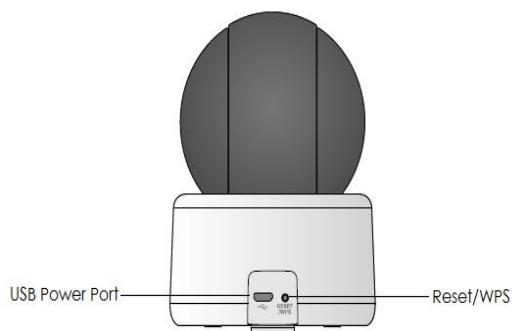

Figure 2-1

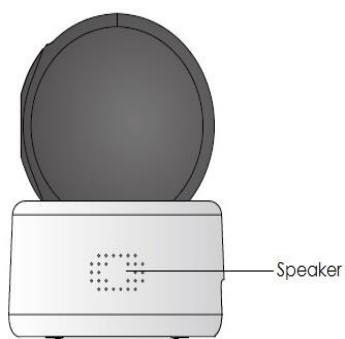

Figure 2-2

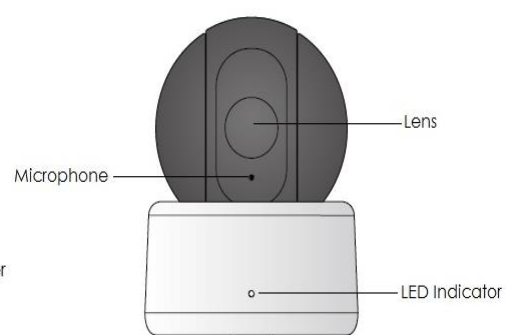

Figure 2-3



## Note

To reset, long press for 10 seconds till the light is off; to enable WPS, just press the button.

Please refer to Table 2-1 for more details about status of indicator light.

Indicator light status	Device status
Red light stably on	Booting
Green light slow flashing	Booting completed, await Wi-Fi config, enter smart config status;
Green light quick flashing	Wi-Fi smart config in progress, including WPS (Wi-Fi Protected Setup), management frame, etc.
Green light stably on	Wi-Fi connection succeeded, operate normally.
Red and green lights flash alternately	Device upgrade
Red light slow flashing	Network disconnection
Red light quick flashing	Device fail to boot up; SD card does not work

Table 2-1

## 3 Operation by Imou App

Step 1 Power on your camera with power adapter.

Step 2 Connect your smartphone to your Wi-Fi network, scan “Imou” QR on the packing box, download and install Imou App.

Step 3 Run Imou App, and register account for first use.

Step 4 Follow the steps below to add your camera (Figure 3-1).



Figure 3-1

### Note

- If you have more cameras, please follow step 4 to add them one by one.
- If you want to change the Wi-Fi signal, please reset the camera to factory default and repeat step 4 to add the camera.

## 4 Device Installation

### Note

Please make sure the mounting surface can sustain at least 3X weight of the camera.

Step 1 Dig holes on the proper mounting surface according to the hole sites of installation position map.

Step 2 Knock the expansion bolts into the holes.

Step 3 Use self-tapping screws to install quick installation board and fix it well.

Step 4 Connect the device to power.



Step 5 Adjust the device monitoring angle and stick the device on the quick installation board.

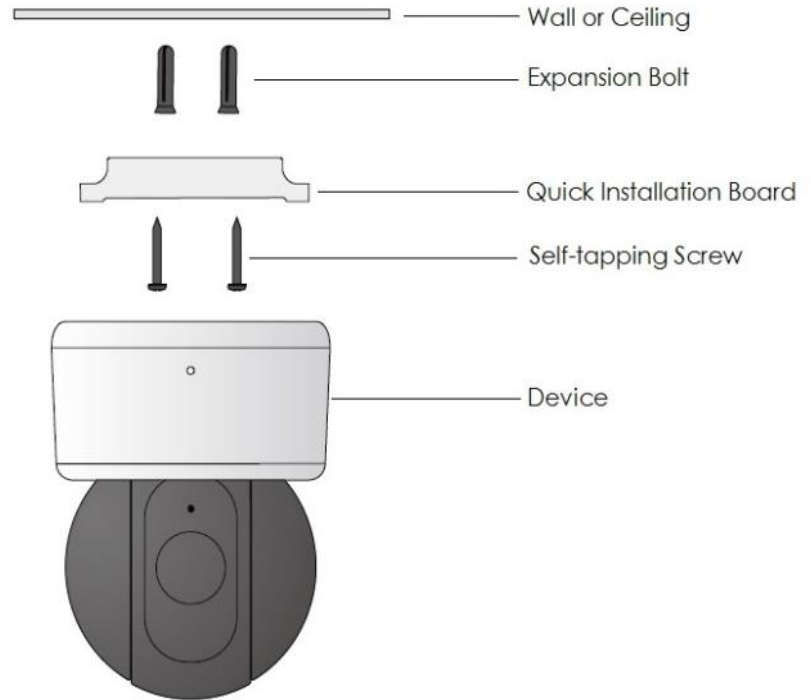

## Disclaimer

- This quick start guide is for reference only. Minor difference might be found in user interface.
- All the designs and software here are subject to change without prior written notice.
- All trademarks and registered trademarks mentioned are the properties of their respective owners.
- Please visit our website or contact your local service engineer for more information.
- If there is any uncertainty or controversy, please refer to our final explanation.

## Kurzanleitung

### 1 Lieferumfang



1 x Gerät



1 x Kurzanleitung

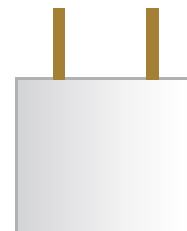

1 x Netzteil



1 x Befestigungsmaterial



1 x Montageplatte



1 x Montageschablone

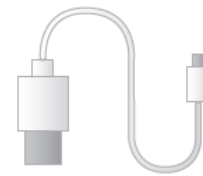

1 x USB-Kabel

### 2 Überblick

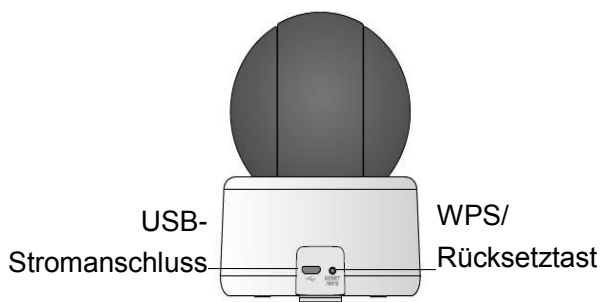

Figure 2-1

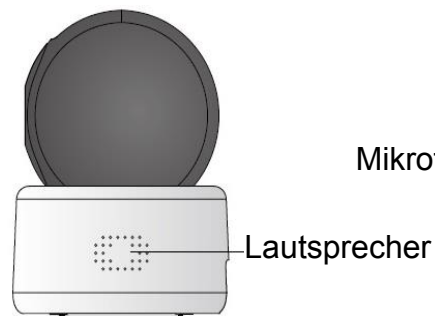

Figure 2-2

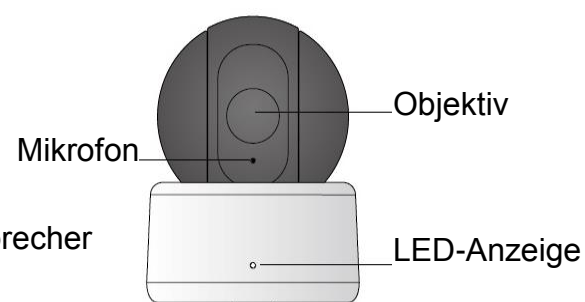

Figure 2-3





## Hinweis

Zum Zurücksetzen halten Sie die WPS/Rücksetztaste für 10 Sekunden gedrückt, bis die Anzeige erlischt. Um WPS zu aktivieren, drücken Sie die Taste einmal kurz.

Nähere Informationen zum Status der LED finden Sie unter Tabelle 2-1.

Anzeigestatus	Gerätestatus
Rote LED leuchtet	Gerät fährt hoch
Grüne LED blinkt langsam	Hochfahren beendet, WLAN-Konfiguration läuft, letzte Konfiguration wird aufgerufen;
Grüne LED blinkt schnell	WLAN Verbindung wird hergestellt
Grüne LED leuchtet	WLAN erfolgreich verbunden, Betrieb normal.
Rote und grüne LED blinken abwechselnd	Geräteaktualisierung
Rote LED blinkt langsam	Keine Verbindung zum Netzwerk
Rote LED blinkt schnell	Gerät startet nicht, Fehler mit der SD-Karte

Tabelle 2-1

## 3 Bedienung über Imou-App

Schritt 1 Verbinden Sie Ihre Kamera mit dem mitgelieferten Netzteil

Schritt 2 Verbinden Sie Ihr Smartphone mit Ihrem WLAN-Netzwerk, scannen Sie den "Imou" QR-Code auf der Verpackung, laden Sie die Imou-App herunter und installieren Sie sie.

Schritt 3 Starten Sie die Imou-App und registrieren Sie sich

Schritt 4 Führen Sie die folgenden Schritte aus, um Ihre Kamera hinzuzufügen

(Abbildung 3-1).



Abbildung 3-1

## Hinweis

- Wenn Sie mehrere Kameras haben, folgen Sie Schritt 4, um sie nacheinander hinzuzufügen.
- Wenn Sie das WLAN ändern möchten, setzen Sie die Kamera auf die Werkseinstellungen zurück und wiederholen Sie Schritt 4, um die Kamera hinzuzufügen.

## 4 Installation des Geräts

### Hinweis

Vergewissern Sie sich, dass die Montagefläche mindestens das 3-fache Gewicht der Kamera tragen kann.



Schritt 1. Bohren Sie Löcher gemäß der Montageschablone (Wand oder Decke).

Schritt 2. Setzen Sie die Dübel ein.

Schritt 3. Schrauben Sie das Gerät mit den  
Schrauben an (Wand oder Decke).

Schritt 4. Schließen Sie das Gerät am  
Stromnetz an.

Schritt 5. Stellen Sie den Überwachungswinkel  
ein und befestigen Sie das Gerät auf  
der Schnellmontageplatte.

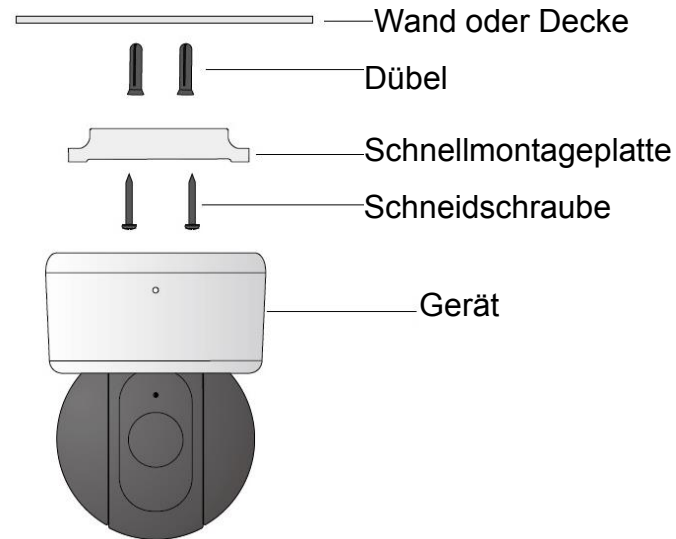

## Haftungsausschluss

- Diese Kurzanleitung dient nur als Referenz. Die Benutzeroberfläche kann geringfügig abweichen.
- Änderung des Designs und der Software vorbehalten.
- Alle hier erwähnten Marken oder eingetragenen Marken sind Eigentum ihres jeweiligen Besitzers.
- Für weitere Informationen besuchen Sie bitte unsere Website oder wenden Sie sich an Ihren örtlichen Kundendiensttechniker. Bei Unklarheiten oder Widersprüchen konsultieren Sie unsere endgültige Erläuterung.

## Guía de inicio rápido

### 1 Contenido



1 cámara



1 guía de inicio rápido

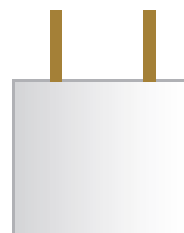

1 adaptador eléctrico



1 bolsa con tornillos

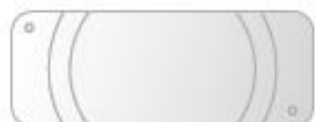

1 placa de instalación rápida



1 plantilla de instalación

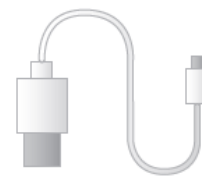

1 USB

### 2 Apariencia del producto



Figure 2-1

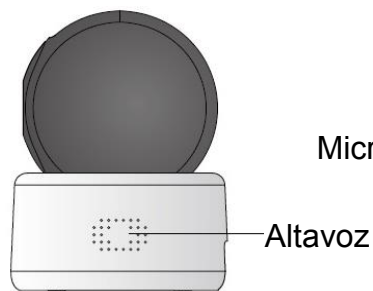

Figure 2-2

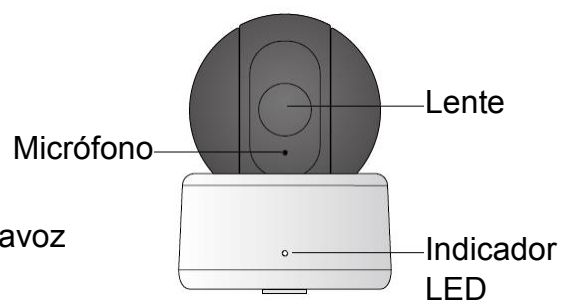

Figure 2-3



## Nota

Para reiniciar, mantenga pulsado durante 10 segundos hasta que se apague la luz.

Para habilitar el WPS, solo pulsar el botón.

Consulte la Tabla 2-1 para conocer más detalles sobre el estado de la luz indicadora.

Estado de la luz indicadora	Estado del dispositivo
Luz roja estable encendida	Arranque
Luz verde parpadeante lenta	Arranque finalizado, esperando configuración wifi. Entrando en el estado de configuración inteligente.
Luz verde parpadeante rápida	Configuración inteligente Wi-Fi en progreso, incluido el marco de gestión, WPS (Wi-Fi Protected Setup), etc.
Luz verde estable encendida	Conexión Wi-Fi correcta, funcionamiento normal.
Luz roja y luz verde parpadeantes alternativamente	Actualización del dispositivo
Luz roja parpadeante lenta	Desconexión de red
Luz roja parpadeante rápida	Erro del dispositivo al arrancar; la tarjeta SD no funciona

Tabla 2-1

## 3 Funcionamiento usando la aplicación Imou

Paso 1 Encienda la cámara con el adaptador eléctrico.

Paso 2 Conecte su smartphone a la red Wi-Fi, escanee el código QR de “Imou” que se encuentra en la caja, descargue la aplicación Imou e instálela.

Paso 3 Ejecute la aplicación Imou y registre una cuenta para empezar a usarla.



Paso 4 Siga los pasos siguientes para agregar su cámara (Figura 3-1).



Figura 3-1

### Nota

- Si tiene más cámaras, repita el paso 4 para agregarlas una a una.
- Si desea cambiar la señal Wi-Fi, reinicie la cámara a la configuración de fábrica y repita el paso 4 para agregar la cámara.

## 4 Instalación del dispositivo

### Nota

Compruebe que la superficie de montaje pueda soportar 3 veces el peso de la cámara.

Paso 1. Taladre los orificios en la superficie de montaje de acuerdo con la posición de los orificios en la plantilla de instalación.

Paso 2. Introduzca los pernos de expansión en los orificios con un martillo.



Paso 3. Utilice los tornillos autorroscantes para instalar y fijar correctamente la placa de instalación rápida.

Paso 4. Conecte el dispositivo a la alimentación eléctrica.

Paso 5. Ajuste el ángulo de monitorización del dispositivo y fije el dispositivo sobre la placa de instalación rápida.

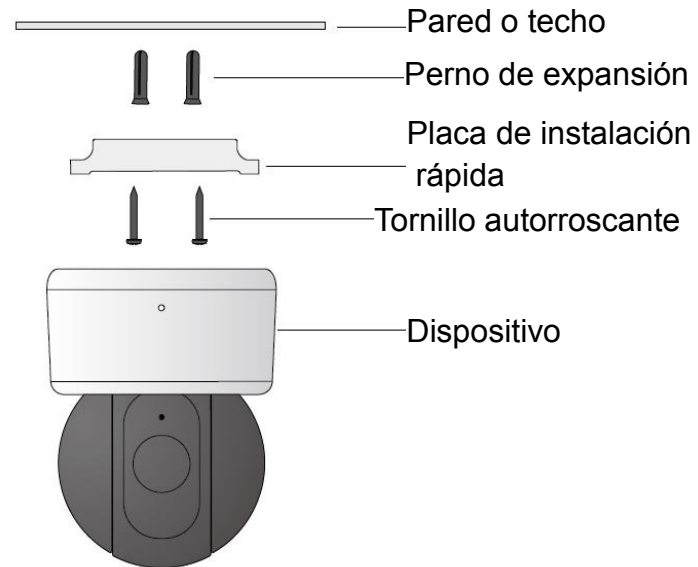

## Descargo de responsabilidad

- Esta guía de inicio rápido es solo una referencia. Es posible que existan pequeñas diferencias en el interfaz de usuario.
- Todos los diseños y el software aquí incluidos están sujetos a cambios sin aviso previo por escrito.
- Todas las marcas comerciales y marcas registradas mencionadas son propiedad de sus respectivos propietarios.
- Visite nuestra página web o contacte con nuestros técnicos del servicio local para más información.
- Si hubiera incertidumbres o controversias, consulte nuestra explicación final.



## Guide de démarrage rapide

### 1 Contenu de l'emballage



Appareil × 1



Guide de démarrage rapide × 1

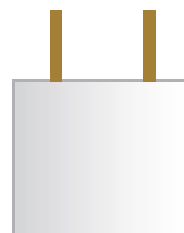

Adaptateur d'alimentation × 1



Jeu de vis × 1



Panneau d'installation rapide × 1



Patron d'installation × 1

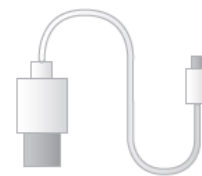

1 USB

### 2 Différentes faces du produit

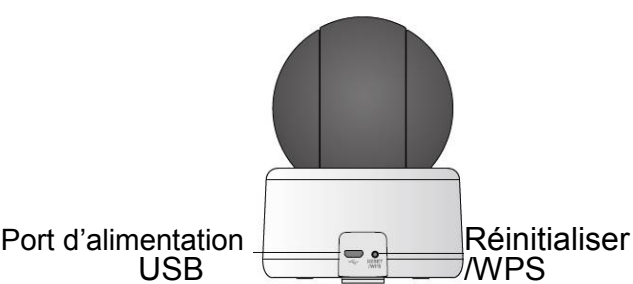

Figure 2-1

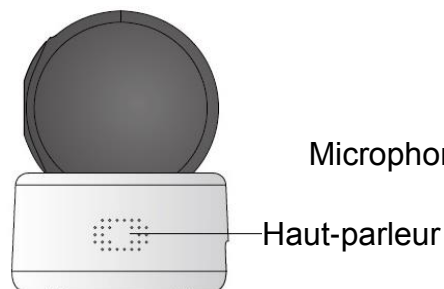

Figure 2-2

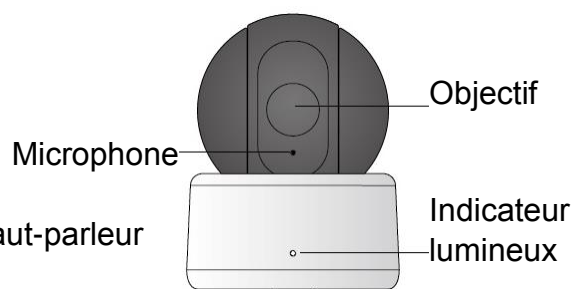

Figure 2-3





## Remarque

Pour réinitialiser l'appareil, appuyez pendant 10 secondes jusqu'à ce que le voyant s'éteigne. Pour activer la fonction WPS, appuyez simplement.

Vous pouvez vous référer à la Tableau 2-1 pour plus d'informations sur l'état de fonctionnement de l'équipement en fonction de son voyant.

État du voyant	État de l'appareil
Voyant rouge fixe	Amorçage
Clignotement vert lent	Fin d'amorçage, en attente de la configuration Wi-Fi, début de la configuration automatique ;
Clignotement vert rapide	Configuration automatique du Wi-Fi en cours, y compris WPS (configuration Wi-Fi protégée), trame de gestion, etc.
Voyant vert fixe	Connexion Wi-Fi établie, fonctionnement normal.
Clignotement rouge et vert alterné	Mise à niveau de l'appareil
Clignotement rouge lent	Déconnexion du réseau
Clignotement rouge rapide	Échec du démarrage ; carte SD non fonctionnelle

Tableau 2-1

## 3 Fonctionnement avec l'application Imou

Étape 1 Allumez votre caméra en branchant l'adaptateur d'alimentation.

Étape 2 Connectez votre smartphone au réseau Wi-Fi ; scannez le code QR de l'application « Imou » figurant sur l'emballage, puis téléchargez et installez l'application « Imou ».

Étape 3 Exécutez l'application et inscrivez-vous pour la toute première utilisation.

Étape 4 Suivez les étapes ci-dessous pour ajouter votre caméra (Figure 3-1).



Figure 3-1

## Remarque

- Si vous avez plusieurs caméras, veuillez suivre à nouveau l'étape 4 pour les ajouter une par une.
- Pour modifier le signal Wi-Fi, veuillez restaurer les paramètres d'usine de la caméra et suivre l'étape 4 pour ajouter la caméra.

## 4 Installation de l'appareil

**Remarque:** Assurez-vous que la surface d'installation soit prévue pour supporter au moins le triple du poids de la caméra.

Étape 1. À l'aide du patron fourni et d'un crayon, repérez sur la surface d'installation les trous à percer sur une surface d'installation appropriée

Étape 2. Percez des trous à l'aide d'une perceuse et d'un foret adapté.

Étape 3. Insérez les chevilles à expansion dans les trous ainsi créés.

## Étape 4. Utilisez les vis

autotaraudeuses pour installer convenablement le panneau d'installation rapide.

## Étape 5. Branchez l'appareil sur l'alimentation.

## Étape 6. Ajustez l'angle de surveillance de la caméra et fixez la caméra sur le panneau d'installation rapide.

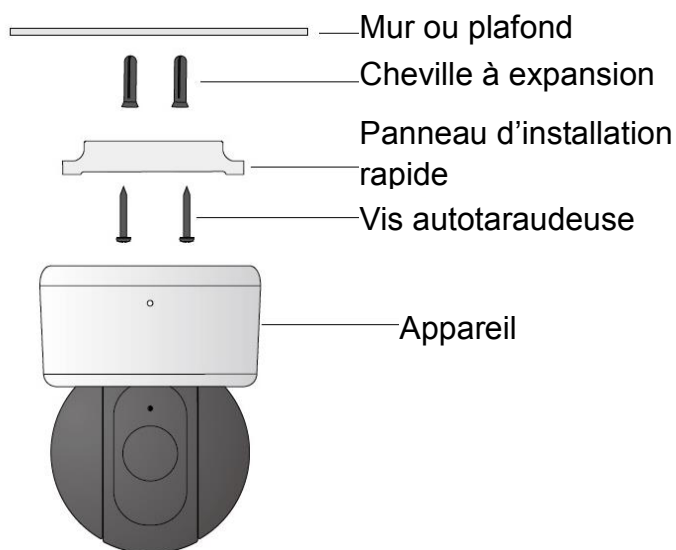

## Avertissement

- Ce guide de démarrage rapide est fourni uniquement à titre indicatif. De légères différences peuvent exister au niveau de l'interface utilisateur.
- Tous les logiciels et toutes les interfaces présentés ici sont susceptibles d'être modifiés sans préavis.
- Toutes les marques et les modèles déposées mentionnées dans le présent manuel appartiennent à leurs propriétaires respectifs.
- Consultez notre site Internet ou contactez votre service technique local pour plus d'informations. En cas de doute ou de non-concordance, veuillez vous référer à la dernière version de cette notice.

## Snelstartgids

### 1 Paklijst



Apparaat \*1



Snelstartgids \*1

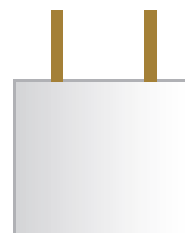

Voedingsadapter \*1



Schroevenpakket \*1



Quick Installation Board \*1



Positioneringskaart t.b.v . installatie \*1

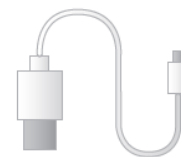

USB-kabel \*1

### 2 Kenmerken van het product

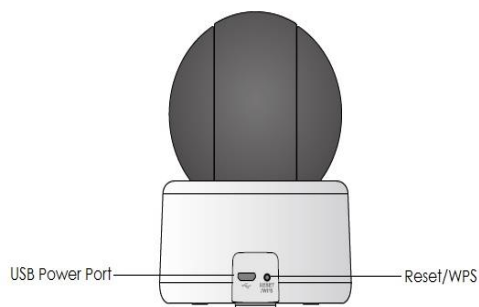

Figure 2-1

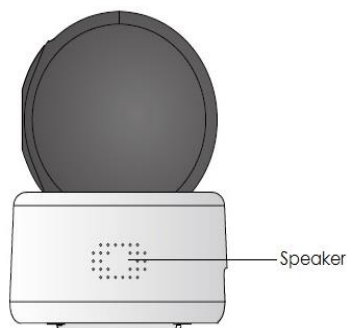

Figure 2-2

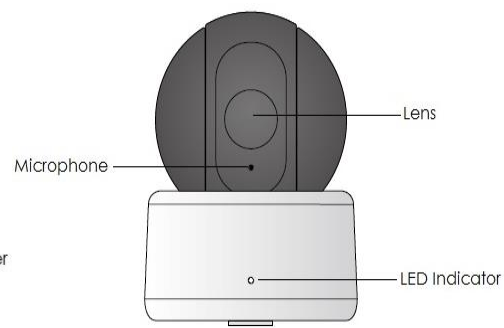

Figure 2-3



**Opmerking:** Om te resetten, houdt de resetknop voor 10 seconden ingedrukt totdat het lampje uitgaat; één keer kort indrukken voor WPS.

Raadpleeg tabel 2-1 voor meer informatie over de status van het indicatielampje.

Status indicatielampje	Status apparaat
Rood lampje aan	Bezig met opstarten
Langzaam knipperend groen lampje	Opstarten voltooid, wacht op Wi-Fi-config, activeer slimme config-status
Snel knipperend groen lampje	Slimme Wi-Fi-config in behandeling, inclusief WPS, managementframe, enz.
Groen lampje aan	Wi-Fi-verbinding geslaagd, normale werking.
Rood en groen lampje knippert afwisselend	Apparaat is aan het upgraden
Langzaam knipperend rood lampje	Netwerkverbinding mislukt of verbreking na gelukke netwerkverbinding.
Snel knipperend rood lampje	Storing apparaat, opstarten mislukt; storing alarm of SD-kaart

Tabel 2-1

### 3 Bediening via de Imou App

Stap 1 Zet het apparaat aan met behulp van de voedingsadapter.

Stap 2 Verbind uw smartphone met uw Wi-Fi-netwerk. Scan de QR code op de verpakking van uw Imou product en download en installeer vervolgens de Imou App.

Stap 3 Open de Imou App en registreer een account voor het eerste gebruik.

Stap 4 Volg de hieronder aangegeven stappen om uw camera toe te voegen



Afbeelding 3-1

## Opmerking

- Indien u meerdere camera's heeft, kunt u stap 4 herhalen om de camera's één voor één toe te voegen.
- Indien u een ander Wi-Fi netwerk wenst te gebruiken, kunt u de camera herstellen naar de fabrieksinstellingen en vervolgens stap 4 herhalen om de camera opnieuw toe te voegen.

## 4 Installatie van het apparaat

**Opmerking:** Zorg er voor het installeren voor dat het oppervlak waarop de camera wordt geïnstalleerd ten minste driemaal het gewicht van de camera kan ondersteunen.

Stap 1 Boor gaten in het montagevlak (muur of plafond) aan de hand van de bijgeleverde positioneringskaart.

Stap 2 Open het zakje met accessoires, haal de expanderbout eruit en plaats deze in het gat dat u zojuist heeft geboord.

Stap 3 Open het zakje met accessoires en haal de montageschroeven eruit. Draai de schroeven vast om het apparaat op het montageoppervlak (wand of plafond) te bevestigen.

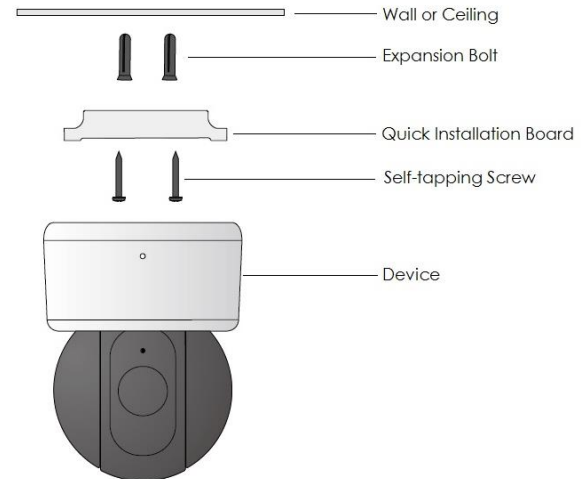

Stap 4 Sluit het apparaat aan op de voeding.

Stap 5 Pas de hoek van de lens aan en bevestig het apparaat op het 'quick installation board'.

## Opmerking

- Deze snelstartgids is uitsluitend bedoeld voor referentie. Er kunnen kleine verschillen voorkomen in de gebruikersinterface.
- Alle hier beschreven ontwerpen en software zijn onderworpen aan wijzigingen zonder voorafgaande schriftelijke mededeling.
- Alle genoemde handelsmerken en geregistreerde handelsmerken zijn eigendom van hun respectievelijke eigenaars.
- Indien er sprake is van onduidelijkheid of controverse, verwijzen wij u door naar onze laatste verklaring.
- Bezoek onze website of neem voor meer informatie contact op met uw lokale leverancier van de camera.

## Guida introduttiva

### 1 Contenuto della confezione



Dispositivo × 1



1 Guida introduttiva

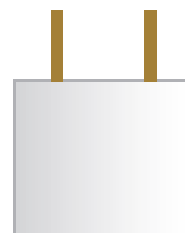

1 Adattatore



1 Kit di viti



1 Piastra d'installazione rapida



1 dima di foatura

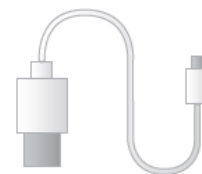

1 Cavo USB

### 2 Come si presenta il prodotto

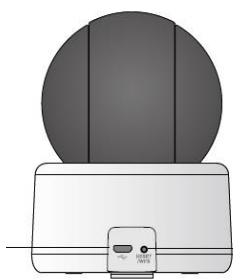

Figure 2-1

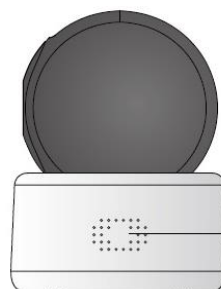

Figure 2-2

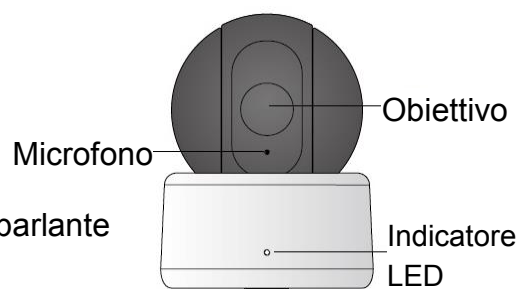

Figure 2-3

Porta di alimentazione USB

Reimposta WPS

Altoparlante

Microfono

Obiettivo

Indicatore LED





**Nota:** Per reimpostare il dispositivo, tenere premuto per 10 secondi il pulsante, fino allo spegnimento della spia luminosa, mentre per abilitare il WPS premere brevemente il pulsante.

Fare riferimento a Tabella 2-1 per ulteriori informazioni sullo stato dell'indicatore luminoso.

Stato indicatore luminoso	Stato del dispositivo
Indicatore rosso fisso	Avvio
Indicatore verde che lampeggia lentamente	Avvio completato, attendere la configurazione Wi-Fi, accedere allo stato di configurazione intelligente;
Indicatore verde che lampeggia rapidamente	Configurazione Wi-Fi intelligente in corso, tra cui la configurazione WPS (Wi-Fi Protected Setup), frame di gestione, ecc.
Indicatore verde fisso	Connessione Wi-Fi eseguita con successo, il dispositivo funziona normalmente.
Gli indicatori rosso e verde lampeggiano in sequenza alternata	Dispositivo in fase di aggiornamento
Indicatore rosso che lampeggia lentamente	Disconnessione della rete
Indicatore rosso che lampeggia rapidamente	Avvio del dispositivo non riuscito; la scheda SD non funziona

Tabella 2-1

### 3 Funzionamento tramite app Imou

Fase 1 Accendere la telecamera con l'adattatore di alimentazione.



Fase 2 Connettere lo smartphone alla rete Wi-Fi, effettuare la scansione del codice QR "Imou" sulla confezione, scaricare e installare l'app Imou.

Fase 3 Eseguire l'app Imou e registrare il proprio account per iniziare l'utilizzo.

Fase 4 Applicare le istruzioni seguenti per aggiungere la telecamera (Figura 3-1).



Figura 3-1

## Nota

- Disponendo di più telecamere, applicare ripetutamente la fase 4 per aggiungerle una alla volta.
- Per modificare il segnale della rete Wi-Fi, occorre ripristinare le impostazioni di fabbrica della telecamera e ripetere la fase 4 per aggiungerla.

## 4 Installazione dispositivo

**Nota:** Assicurarsi che la superficie di installazione sia in grado di sostenere un peso pari ad almeno tre volte quello della telecamera.

Fase 1. Praticare i fori su una superficie di installazione idonea, nelle posizioni

indicate sulla mappa di installazione.

Fase 2. Inserire i tasselli a espansione nei fori.

Fase 3. Servendosi delle viti autofilettanti, installare e fissare saldamente la piastra di installazione rapida.

Fase 4. Collegare il dispositivo all'alimentazione.

Fase 5. Dopo averne regolato l'angolo di

monitoraggio, sistemare il dispositivo sulla piastra di installazione rapida.

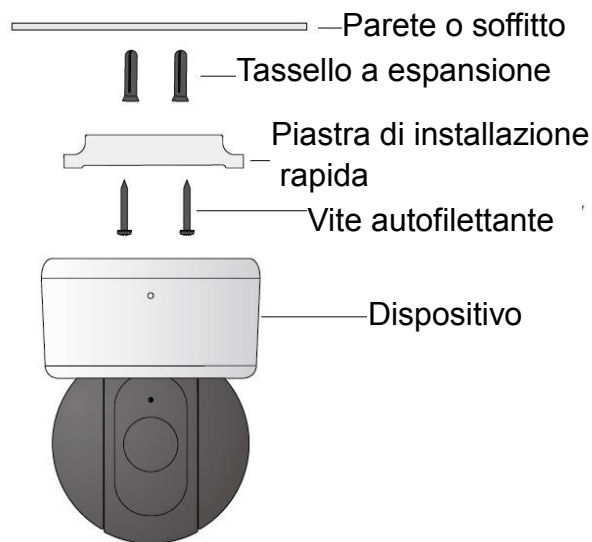

## Dichiarazione di non responsabilità

- La guida introduttiva serve solo come riferimento. L'interfaccia utente potrebbe risultare leggermente diversa.
- Grafiche e software sono soggetti a modifica senza preavviso.
- Tutti i marchi e i marchi registrati citati sono di proprietà dei rispettivi titolari.
- Per maggiori informazioni, visitare il nostro sito o contattare il tecnico di zona.
- In caso di incertezze o controversie, fare riferimento alla spiegazione finale.

## Guia de Início Rápido

### 1 Lista da embalagem



Dispositivo × 1



QSG × 1

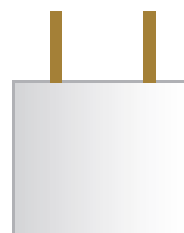

Adaptador de corrente × 1



Embalagem de parafusos × 1



Placa de instalação rápida × 1



Mapa de posicionamento de instalação × 1

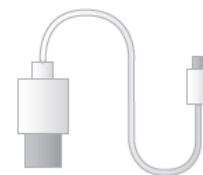

USB × 1

### 2 Aspeto do produto



Figure 2-1

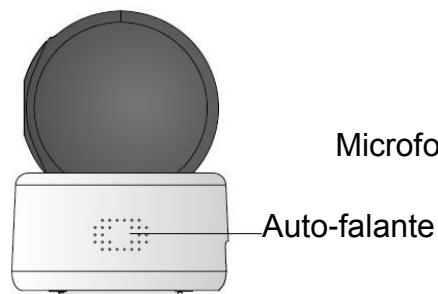

Figure 2-2

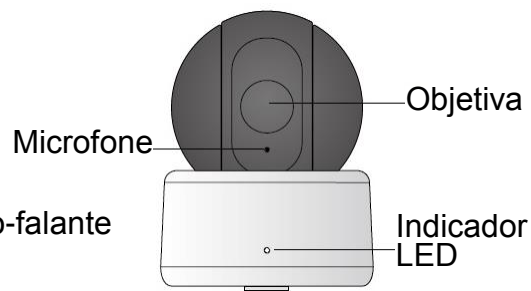

Figure 2-3



## Observações

Para a reposição prima sem soltar durante 10 segundos até que a luz se desligue; para ativar WPS basta uma breve pressão do botão.

Consulte a Tabela 2-1 para mais detalhes sobre o estado da luz do indicador.

Estado da luz indicadora	Estado do dispositivo
Luz vermelha fixa acesa	Arranque
Luz verde lentamente intermitente	Arranque concluído, a aguardar configuração de Wi-Fi, introduzir estado de configuração inteligente;
Luz verde rapidamente intermitente	Configuração Wi-Fi inteligente em curso, incluindo WPS (configuração protegida de Wi-Fi), gestão da trama, etc.
Luz verde fixa acesa	Ligação de Wi-Fi bem-sucedida, funcionamento normal.
As luzes vermelha e verde ficam intermitentes, alternadamente	Atualização do dispositivo
Luz vermelha lentamente intermitente	Desligado da rede
Luz vermelha rapidamente intermitente	O arranque do dispositivo falhou; o cartão SD não funciona

Tabela 2-1

## 3 Operação pela Aplicação Imou

Passo 1 Ligue a câmara com o adaptador de corrente.

Passo 2 Ligue os seu smartphone à rede Wi-Fi, efetue a leitura do código QR

"Imou" na embalagem, transfira a instale a Aplicação Imou.



Passo 3 Execute a Aplicação Imou e crie uma conta na primeira utilização.

Passo 4 Siga os passos abaixo para adicionar a sua câmara (Figura 3-1).



Figura 3-1

## Observações

- Se tem mais câmaras, siga o passo 4 para as adicionar uma-por-uma.
- Se quiser alterar o sinal Wi-Fi, reponha as predefinições da câmara e repita o passo 4 para adicionar a câmara.

## 4 Instalação do dispositivo

**Observações:** Certifique-se de que a superfície de montagem pode suportar, pelo menos, 3x o peso da câmara.

Passo 1. Perfure orifícios na superfície de montagem de acordo com os locais dos orifícios no mapa de posição da instalação.

Passo 2. Bata os parafusos de expansão para dentro dos orifícios.

Passo 3. Utilize parafusos autorroscantes para instalar a placa de instalação rápida

e para a fixar bem.

Passo 4. Ligue o dispositivo à alimentação.

Passo 5. Ajuste o ângulo de monitorização do dispositivo e fixe o dispositivo na placa de instalação rápida.

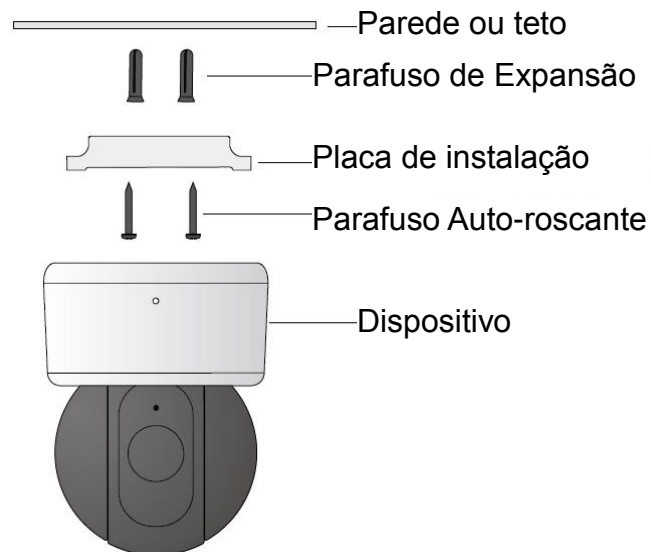

## Isenção de responsabilidade

- Este guia de início rápido destina-se apenas a consulta. Podem ser encontradas diferenças mínimas na interface do utilizador.
- Todos os designs e software aqui incluídos estão sujeitos a alterações sem aviso prévio.
- Todas as marcas comerciais e marcas registadas aqui mencionadas são propriedade dos seus respetivos proprietários.
- Visite o nosso website ou contacte o seu engenheiro de serviço local para obter mais informações.
- Caso exista alguma dúvida ou controvérsia, consulte a nossa explicação final mais recente.

# imou

Enjoy Smart Life



[E service.global@imoulife.com](mailto:service.global@imoulife.com)

[W www.imoulife.com](http://www.imoulife.com)